

BELLATERRA HOME

Model: 7615 (Counter top sold separately)

Tools List (Not included)



Tape Measure



Silicone

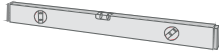

Spirit Level

Use a spirit level to ensure the vanity is level from left to right and front to back, adjust if needed.

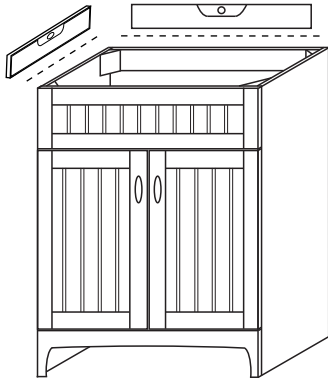

Step 1

Attach the counter top onto the vanity with silicone sealant applied to top of front and side vanity edges. Do not over apply. Allow to dry for 24 hours for proper curing.

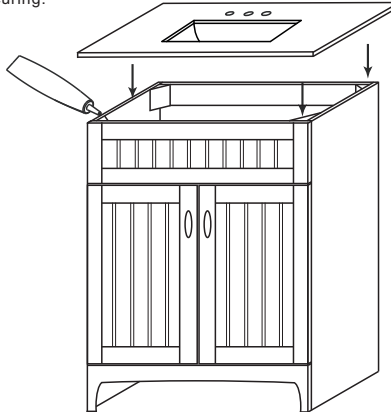

Step 2

Apply silicone sealant evenly along the bottom of backsplash and wall. Backsplash not included and must be purchased separately. Backsplash sold separately.

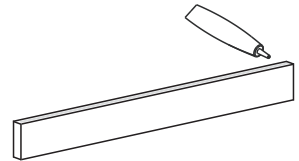

Step 3

Place backsplash on the surface of the counter with the siliconed side down. Check for alignment and let it dry for 24 hours. Skip this step if backsplash was not purchased.

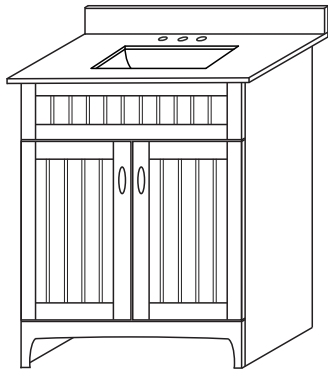

Step 4

Please refer to the following dimensions of faucet holes for vanities with undermount square sink.

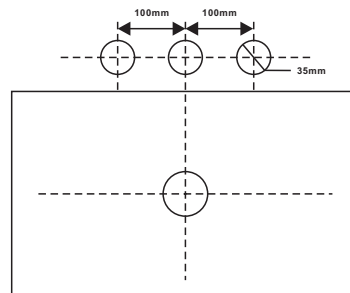

Faucet hole specification-1

Please refer to the following dimensions of faucet holes for vanities with undermount oval sink.

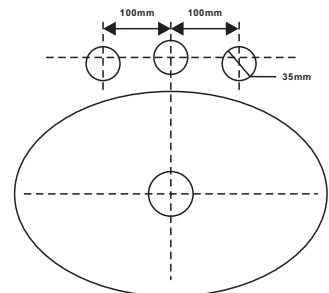

Faucet hole specification-2

CARE AND CLEANING

For best results in caring for your stone top, we suggest:

- Always wipe off spills immediately.
- Seal the stone top regularly with a good quality stone sealant.
- Never use strong or abrasive cleaner, and always test your cleaning solution on unnoticeable areas before applying to the entire surface.
- Wipe surface clean, immediately after applying cleaner.
- Do not allow cleaner to sit or soak. Never let cleaner sit on the surface of the stone for long periods of time.
- Use a soft, dampened sponge and cloth. Never use an abrasive material such as brush or scouring pad to clean surface. They will scratch the surface of the stone top and lavatory
- Always rinse and wipe clean the fixtures to prevent soap buildup.

INSTALLATION TIPS:

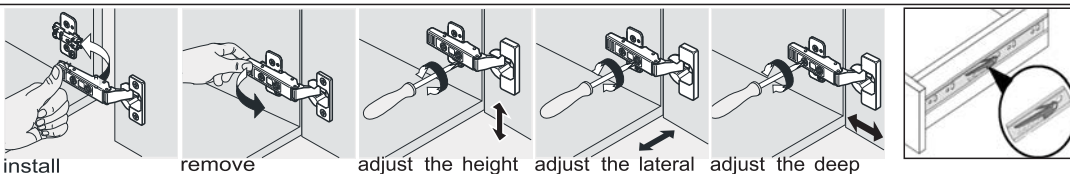

press down the pin on this side & press up the one on another side to pull out the drawer box.

NOTE: SINK STYLE, SHAPE, FAUCET HOLES, CUTOUT ON TOP, VANITY MAY VARY FROM THE PICTURE ABOVE. INSTRUCTIONAL PURPOSE ONLY.

Professional installation is recommended.
www.bellaterra-home.com

Bellaterra Home LLC, All Rights Reserved 2015